

Data Sheet

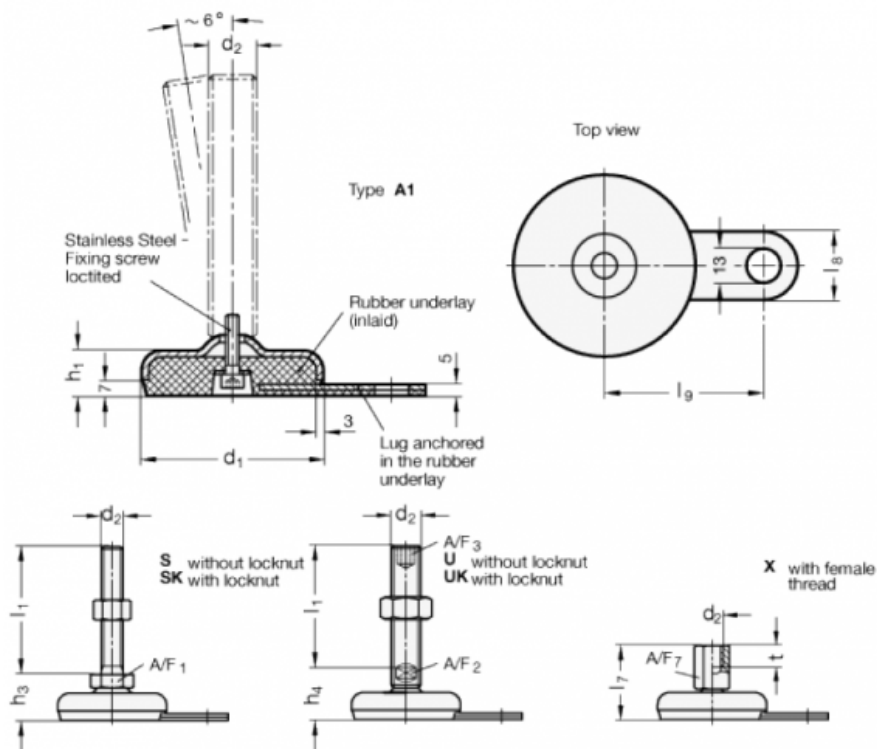

Article number: 2032100M843A1X
Description: E+G levelling foot
GN 32-100-M8-43-A1-X
Note: X With female thread, External hexagon

Measures



A/F7	= 14
d1	= 100
d2	= M8
h1	= 21
l7	= 43
l8	= 30
l9	= 80
t	= 8